

Libreria HOLLY sp. 3 cm a spalla

nidi

HOLLY bookcase with 3cm-thick load-bearing side panels

Libreria a spalla portante sp. 3 cm \ Bookcase with 3cm-thick load-bearing side panels

A TERRA \ FLOOR STANDING

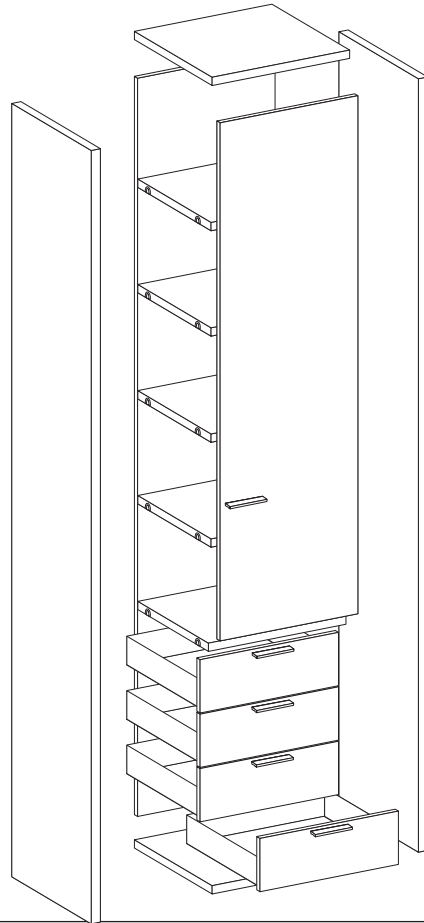

Spalla sp. 3 cm \
Side panel 3 cm thick

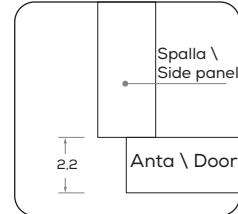

DIMENSIONI GENERALI \ GENERAL DIMENSIONS

Altezze \ Heights

Altezze comprensive di piedini regolabili H 0,7 cm \ Heights include 0,7cm-high adjustable feet.

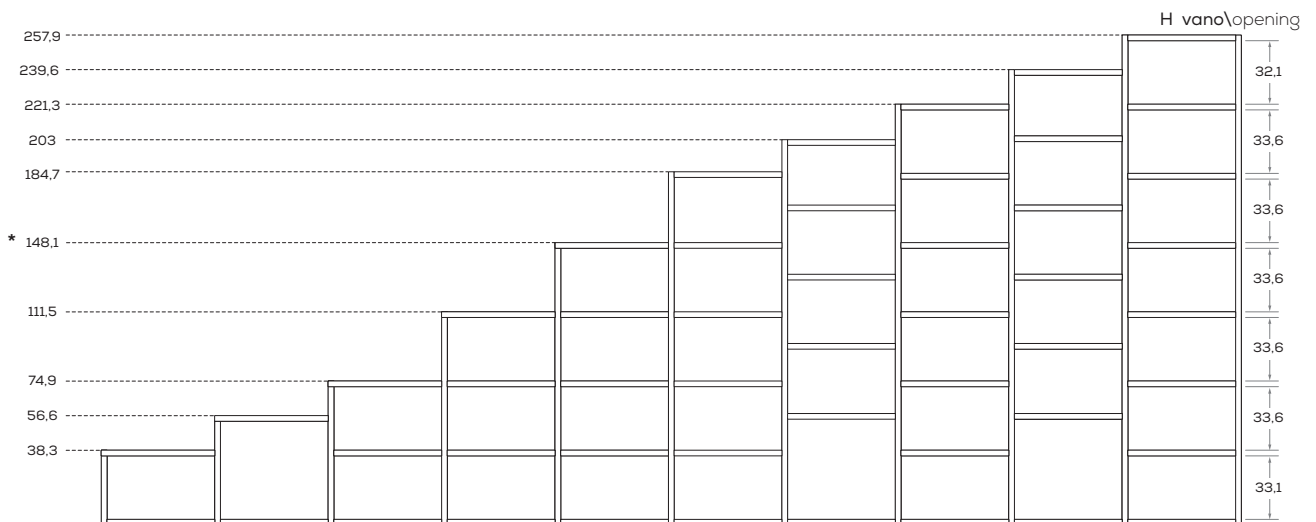

* Il top intero sp. 3 cm, prof. 33 cm, è compreso fino all'altezza 148,1 cm e viene fissato direttamente alle spalle laterali (larghezza massima 300 cm) \ The 3cm-thick, 33cm-deep, one-piece top is included up to a height of 148,1 cm and is fastened straight on top of the end side panels (maximum size 300 cm).the end side panels.

Le informazioni contenute nelle presenti schede tecniche sono indicative. Eventuali differenze con il listino in vigore non costituiscono motivo di contestazione / The information given in this technical sheet are indicative. Any discrepancies with the price list currently in force cannot be cause for complaint.

Larghezze \ Widths

Le larghezze delle librerie HOLLY sono comprensive della spalla iniziale sp. 3 cm \ Widths of HOLLY bookcases include the 3cm-thick side panel at the starting end.

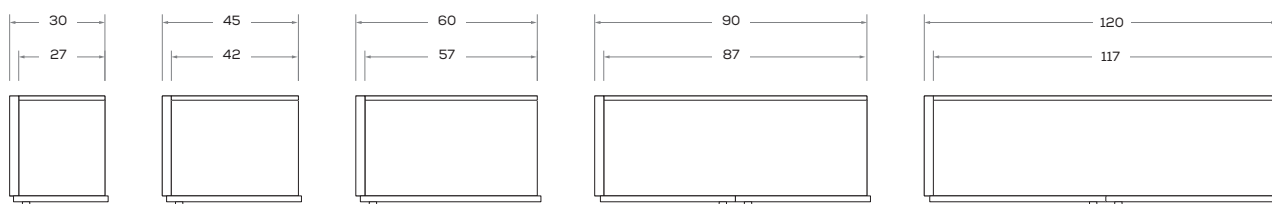

Profondità \ Depths

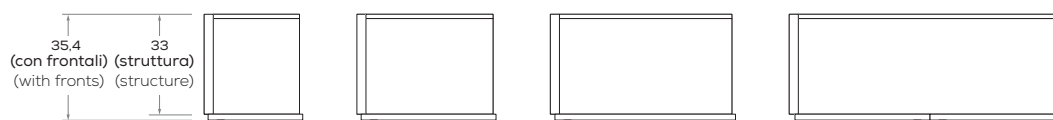

Angolo \ Corner

Le larghezze dei moduli ad angolo sono comprensive della spalla SX spessore 3 cm \ Widths of corner modules include the 3cm-thick LH side panel.

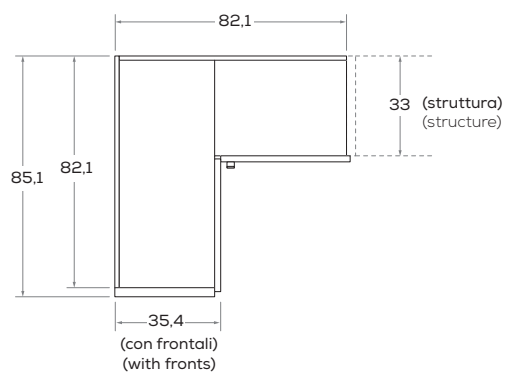

Terminali \ End units

KAM

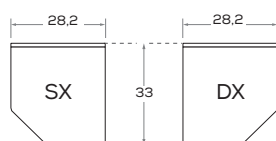

DEN

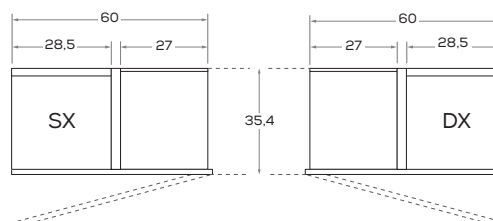

LIBRERIA PONTE \ BRIDGING BOOKCASE

Librerie a ponte sp. 3 cm \ Bridging bookcases 3 cm thick

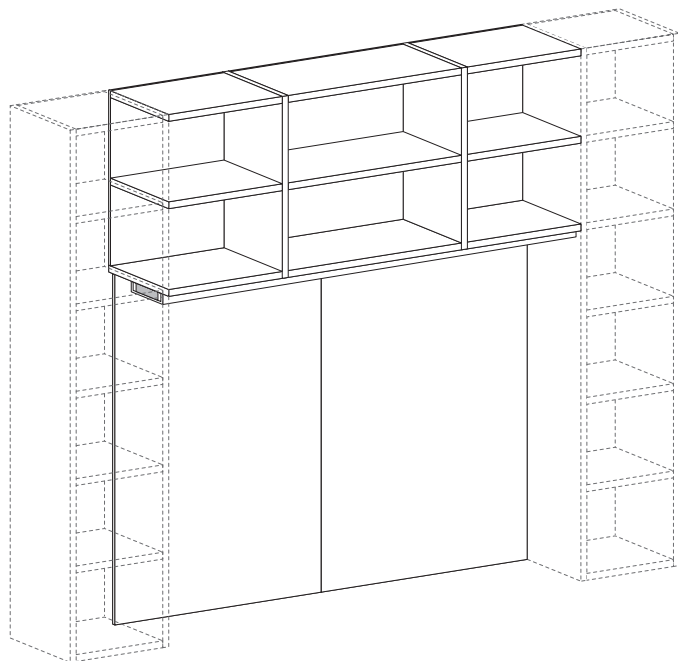

Ponti con pannello sottoponte \ Bridging units with panel underneath

I ponti vengono attrezzati con 1 barra di sostegno \ Bridging units are fitted with 1 support bar.

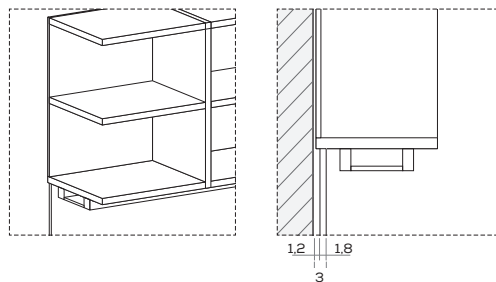

Ponti senza pannello sottoponte \ Bridging units with no panel underneath

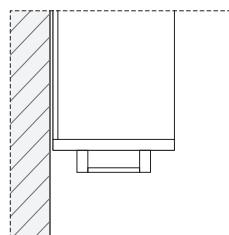

DIMENSIONI GENERALI \ GENERAL DIMENSIONS

Altezze \ Heights

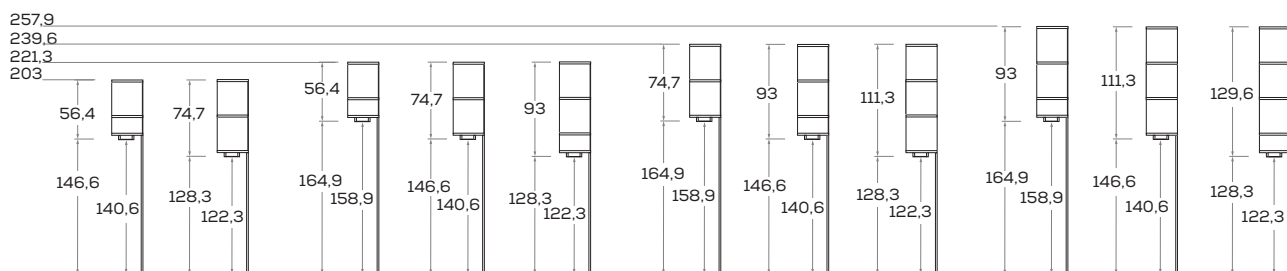

Profondità \ Depths

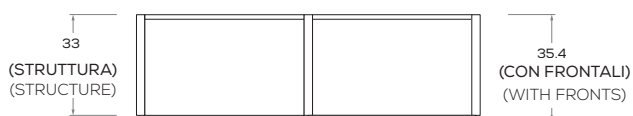

Le informazioni contenute nelle presenti schede tecniche sono indicative. Eventuali differenze con il listino in vigore non costituiscono motivo di contestazione / The information given in this technical sheet are indicative. Any discrepancies with the price list currently in force cannot be cause for complaint.

Larghezze \ Widths

L\W cm 135

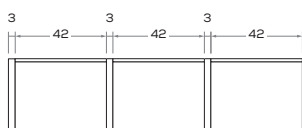

L\W cm 150

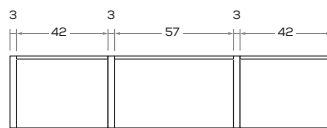

L\W cm 180

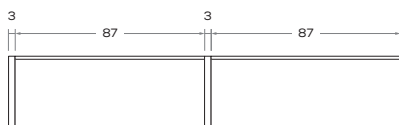
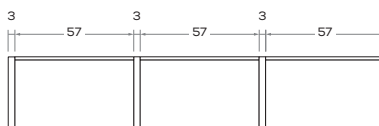
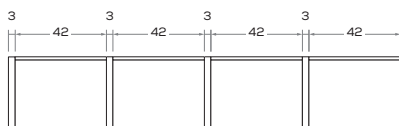

L\W cm 210

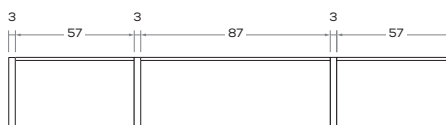
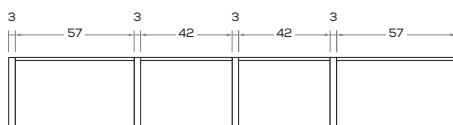

LIBRERIA SOSPESA \ WALL MOUNTED BOOKCASE

Libreria a spalla portante sp. 3 cm \ Bookcase with 3cm-thick load-bearing side panels

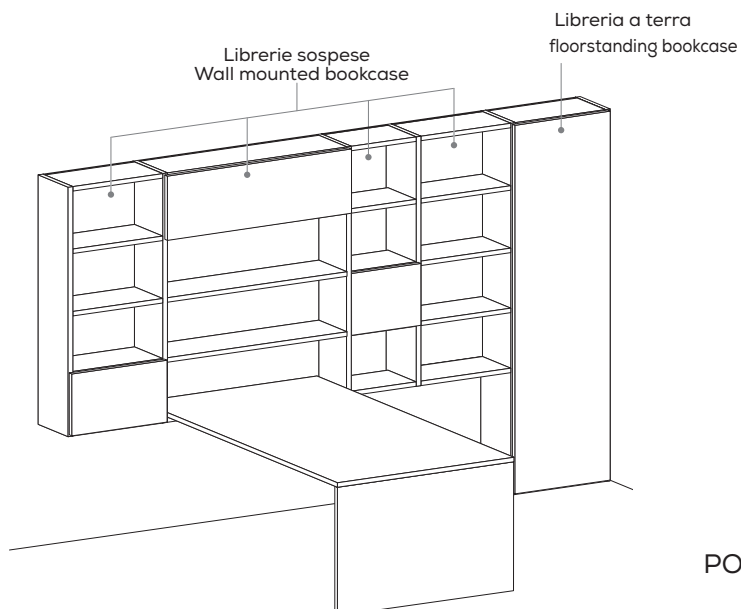

PORTATA MASSIMA PER RIPIANO SP. 3 CM \
3CM-THICK SHELF LOAD CAPACITY

	H 38,1	H 56,4	H 74,7	H 111,3	H 147,9	H 184,5
L\W 30	23 kg	23 kg	23 kg	20 kg	20 kg	20 kg
L\W 45	25 kg	25 kg	25 kg	20 kg	20 kg	20 kg
L\W 60	25 kg	25 kg	25 kg	25 kg	20 kg	20 kg
L\W 90	10 kg	10 kg	10 kg	10 kg	10 kg	8 kg
L\W 120	10 kg	10 kg	10 kg	10 kg	10 kg	

Le informazioni contenute nelle presenti schede tecniche sono indicative. Eventuali differenze con il listino in vigore non costituiscono motivo di contestazione / The information given in this technical sheet are indicative. Any discrepancies with the price list currently in force cannot be cause for complaint.

Altezze \ Heights

Librerie SOSPESE con CAPPELLO \ WALL-MOUNTED bookcases with TOP COVER

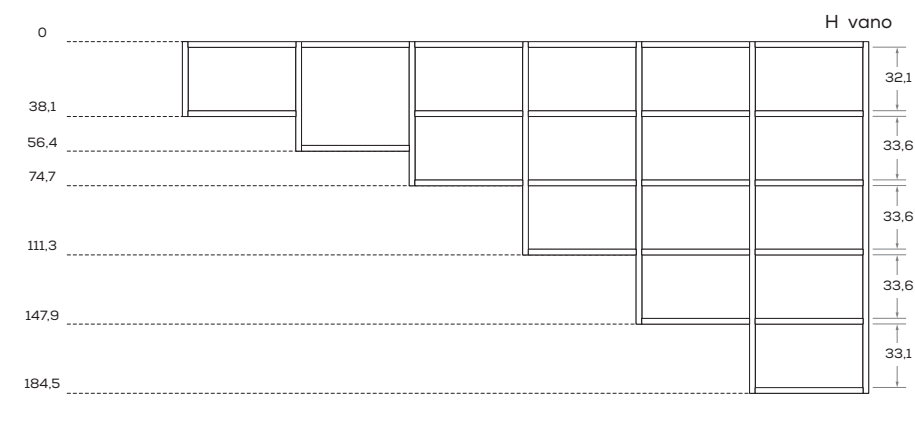

Librerie SOSPESE con TOP INTERO \ WALL-MOUNTED bookcases with ONE-PIECE TOP

Il top viene fissato alle spalle laterali \ The top is fastened to the side panels on the ends.

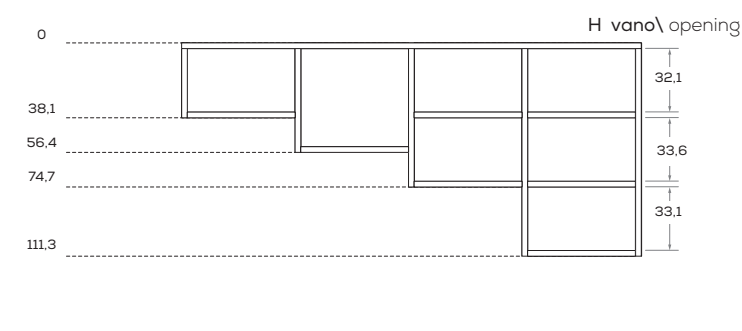

Larghezze \ Widths

Le larghezze delle librerie HOLLY sono comprensive della spalla iniziale sp. 3 cm \ Widths of HOLLY bookcases include the 3cm-thick side panel at the starting end.

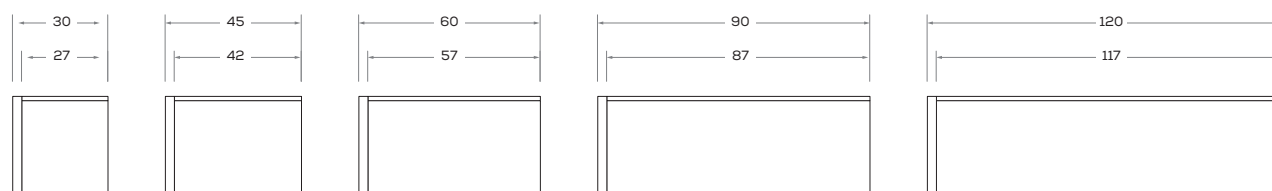

Profondità \ Depths

